



VIRON GAS HEATER



Viron Gas Heater

A product of today's thinking and global challenges

- ✓ Reduces Operating Costs by up to 20%
- ✓ Reduces greenhouse gas emissions
- ✓ Compact Design
- ✓ Swim at any time



Heating on Demand

Heat only when you want to swim.
Convenient and Economical.

Nearly 10 years of intensive research and development by AstralPool, has resulted in the Viron Gas Pool and Spa Heater. Using revolutionary technology, Viron saves energy, reduces greenhouse emissions and reduces water consumption in your pool or spa. And importantly for your family, reduces operating costs without compromising your lifestyle.

VIRON POOL & SPA HEATER

The Viron Pool and Spa Heater squarely faces the issues of greenhouse emissions, energy efficiency and water sustainability all in one compact unit.

With operating efficiencies of up to 97%, Viron reduces operating costs by more than 20% over conventional gas heaters. By absorbing so much heat into the pool water, Viron produces up to 10 litres of condensation per hour which can be piped back into your pool or spa. In fact, in a typical pool heating application Viron can add more than 3000 litres of water to your swimming pool each year, reducing the need to top up your pool.

NATURAL GAS

Natural gas is one of the cleanest and greenest fuels available. With dramatically increased energy efficiency, Viron makes the most of this clean energy source by reducing greenhouse emissions over conventional gas heaters.

STATE OF ART MATERIALS & DESIGN

With state of the art materials and design Viron is less than half the size of other heaters, meaning installation is easier and less intrusive.

AstralPool believe your pool and spa should be a warm oasis, whenever you want to use it. But why waste energy and money to keep it warm just in case you are going to use it.

Many pool and spa heating systems need to be left operating continuously simply because they take days to heat up. Only gas heating provides realistic on demand heating.

Heat Up Time to Raise Pool 12 Degrees

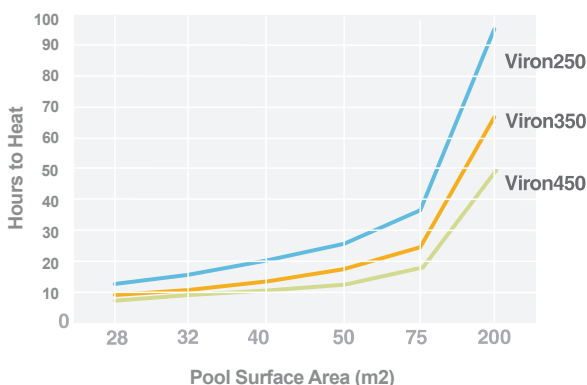

Spa Heat Up Time (20 Degrees)

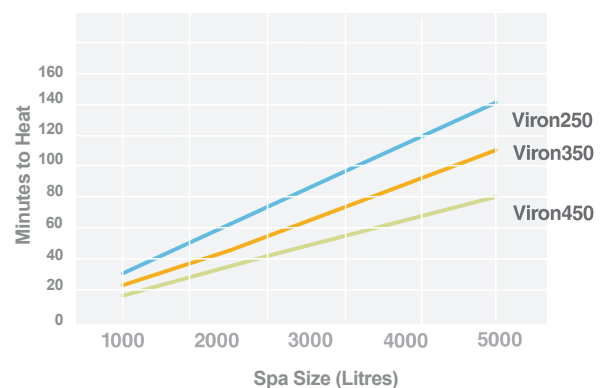

Heating time to heat 13 degrees

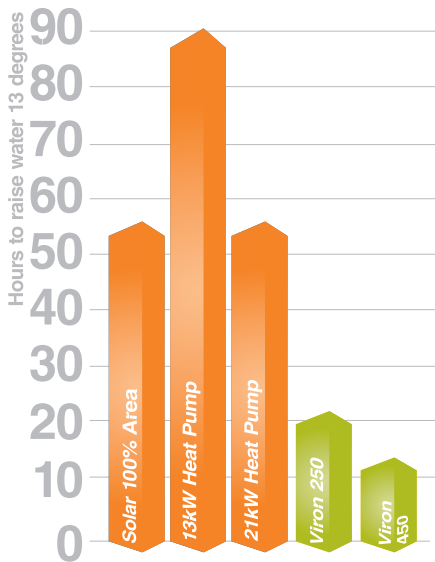

tCO2-e per annum full fuel cycle

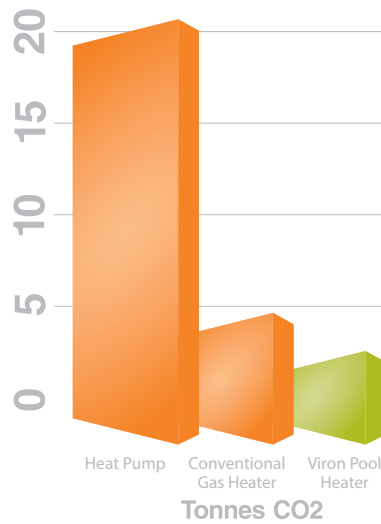
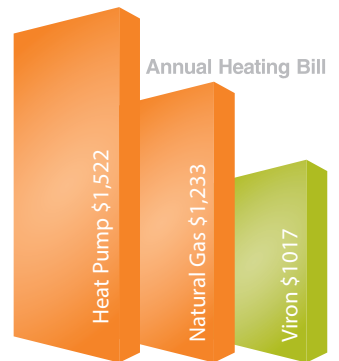

Chart based on Viron and conventional gas heaters used to heat on demand are equivalent to heating a 50,000 litre swimming pool for 96 days per year (during Summer, Easter, Winter and September School Holidays). Heat Pump emissions based on maintenance heating (left heating for 9 months a year at an average COP of 3.5).



Costs based on natural gas pricing in Victoria as of 1/7/10 compared with standard domestic electricity tariff, Gas Heaters used as demand heaters (96 days per year), Heat Pump used as maintenance heater (9 months per year)

SAVE HUNDREDS OF DOLLARS / YEAR

Whether your pool is in a warm sub tropical climate or a cool temperate climate only gas can realistically heat your pool in a few hours. Once the weekend or holidays are finished, simply turn your heater off and save energy, money and minimise water evaporation. The natural gas Viron heater can save you hundreds of dollars per year.

VIRON'S TECHNOLOGY

Viron's technology has been developed around a unique stainless steel knitted mesh burner which fires downwards through multiple layers of extruded finned tube through which the pool or spa water passes. This unique burner utilises a fan which pre-mixes gas and air for perfect combustion, regardless of the water installation or weather conditions.

The heat exchanger absorbs so much heat from the combustion process that the

flue gases condensate. This condensation is then collected and can be returned to the swimming pool. The mildly acidic condensation also helps counter balance the alkaline effects of most chlorines and salt chlorinators, reducing the need to add acid and balance your pool water.

The Genus IV electronic management system monitors pool and spa water temperature, heat exchanger temperature, gas input and the level of condensation for you to enjoy the perfect swimming conditions.

Once your pool heater is within 1 degree of the desired (or set point) temperature, the electronics turn down the firing rate of the heater to match the heat loss of your pool. This achieves a remarkable efficiency of up to 97%. With increased energy efficiency means lower operating costs and reduced green house emissions over both conventional gas heaters and heat pumps.

OPTIONAL VIRON CONNECT 10 CONTROL

The Viron Gas Heater can be connected to the optional Viron Connect 10 Control System which allows intelligent operation and feedback from in the home or anywhere your smart phone or tablet can connect to the internet.

3 MODELS TO SUIT ALL POOLS

The Viron heater is designed to be 30 – 50% smaller than the size of normal conventional gas heaters.

With 3 models available the Viron Pool and Spa Heater enables you to heat your pool or spa on demand, when you want to swim,

saving you money and helping preserve the environment. The Viron heater range is available for both indoor and outdoor plant installation.

WARRANTY

Viron Gas Heater is covered by a 5 year warranty on the cabinet, 2 years on gas valve, circuit boards and burner and 1 year on the heat exchanger.

To find out more about the Viron range visit astralpool.com.au

SPECIFICATIONS

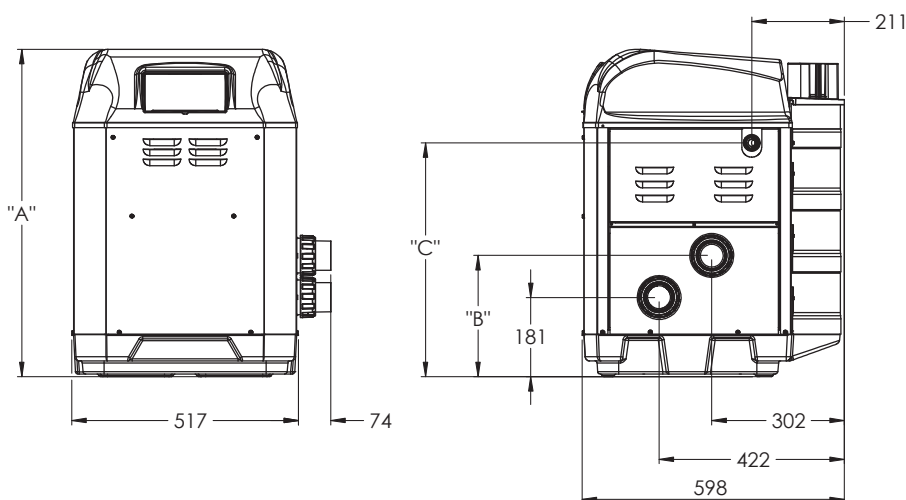

Model	A	B	C
Viron eVo 250 & 350	747mm	276mm	533mm
Viron eVo 450	950mm	386mm	712mm

Australian Patent No.2008271930 & 339581. New Zealand Patent No.582223. Australian Patent Application Nos.2012201784, 2012201782. Australian Patent Application 2013203850

Available from:

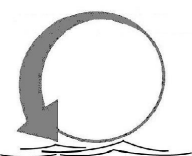

Whiteside Pools

148 Barrington Street, Bibra Lake, WA
 T: (08) 9434 5034
 F: (08) 9438 2343
 E: sales@wsph.com.au
 W: www.pickapoolpart.com.au
 P: PO Box 1562, Bibra Lake WA 6965



A division of
FLUIDRA

Click Here
 To Return to
 Website

